

# ICEpower AS Series

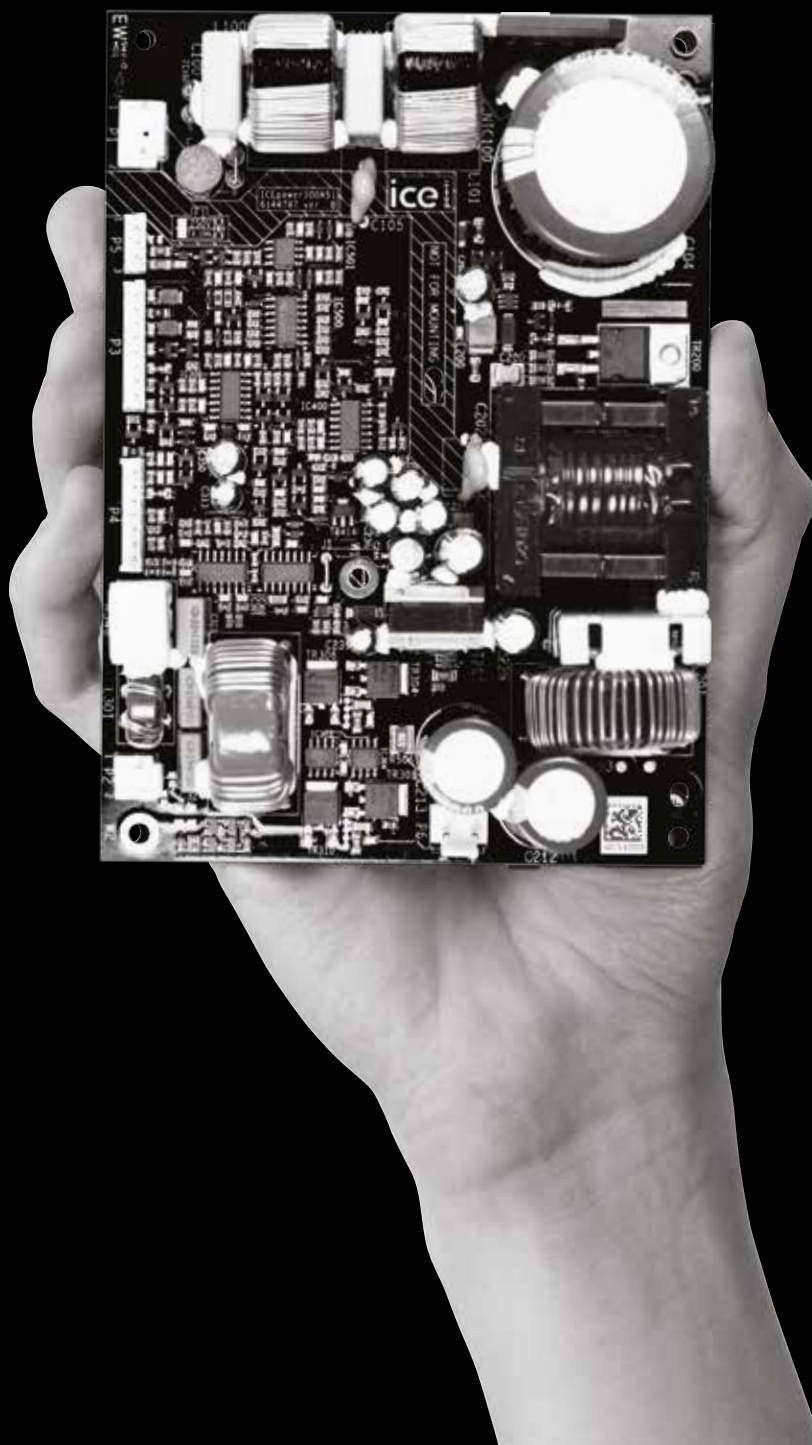



# Dear Audio Manufacturer

In an increasingly competitive, fast paced world, cost and time to market is becoming ever more important. Besides manufacturing cost, product development, logistics and quality costs in many cases contribute significantly to the total cost. In order to provide audio manufacturers with a competitive edge, the ICEpower AS Series has been designed with attention to cost through the entire product life cycle.

For example, to speed up your time to market and reduce your product development cost, we have added all system and housekeeping functions onto the AS modules so you don't need to spend time and money developing them yourself.

Stocking and managing the logistics of delivering a product is expensive. To keep your stock and logistics cost to a minimum, the AS Series is designed with a Universal Mains power supply, eliminating the need to stock both 115V and 230V versions of your product, thereby halving your necessary stock and saving you money.

A product that fails at the end user is expensive. The costs associated with loss of reputation, repairing, replacing or even recalling the product can be significant. The AS Series has been developed with the highest attention to quality to ensure long product life, excellent reliability and very low field failure rates. When developing products with the AS Series, you don't need to worry about quality costs.

So, hasn't all this focus on cost comprised the audio performance? Absolutely not. True to the ICEpower brand promise, the AS Series class D amplifiers are based on proprietary ICEpower class D technologies, ensuring crisp, clear and delicate audio reproduction with a tightly controlled bass response.

Want to listen for yourself? Please contact us at [info@icepower.dk](mailto:info@icepower.dk) to order a sample. We look forward to hearing from you.

# AS Series Overview

The ICEpower AS Series<sup>1</sup> consists of intelligent audio power conversion solutions designed particularly for highly competitive consumer and professional audio applications. The series includes both 1 and 2 channel modules of 100 W, 300 W, 700 W and 1200 W. The key distinguishing qualities of these modules are excellent audio performance, a wide array of features, flexibility and application convenience.

All modules in the AS Series combine high performance class D amplifiers with a universal mains switch mode power supply with standby functionality, auxiliary power supplies, wake on signal sense, 5 V and 12 V triggers, status LED indicators and a DC-bus output for powering additional ICEpower 300A1 amplifiers. Basically everything needed for a bass or guitar amplifier, a subwoofer, an active loudspeaker or a high-end amplifier.

The 300A1 module is essentially the amplifier part of the 300AS1. It is designed to be a "hanger" module, that can be powered from the DC-bus output of the 300AS1, 700AS1/2 or 1200AS1/2. This means that a combination of these modules can be used to create anything from a subwoofer to a stereo amplifier or a 2- or 3-way active loudspeaker. This is what we call design flexibility.

All the AS amplifier modules are based on patented ICEpower modulation and control techniques. This enables excellent audio performance and high efficiency in an ultra-compact and lightweight package.

A full overview of features and specifications is on page 10.

**Note 1:**

AS - Amplifier and Power Supply, e.g.

100AS1 - 100W per channel, Amplifier and Power Supply 1 channel.

# Application Convenience

The ability to bring new products to the market fast, with a minimum of development investment required, is key to surviving in an increasingly competitive global market.

Using an ICEpower amplifier and power supply module is a turn-key approach to product development, that frees up your development resources. This enables you to focus on developing product features that truly differentiate your product rather than spending time on developing amplifiers and power supplies.

To deliver on this promise, the ICEpower AS Series is designed to require no additional heat sinking and is pre-approved for Safety, EMC and RoHS compliance with all certificates available through ICEpower.

The fact that no upfront investments are required for product development means that using an ICEpower standard module secures cost competitiveness even at low manufacturing volumes.

# Applications

The rich feature set and superb audio performance of the AS Series make the modules a perfect match for subwoofers, active loudspeakers and high-end consumer and professional audio applications. The typical applications include:

- Subwoofers
- High-end stereo and multi-channel amplifiers
- Active 2- and 3- way speakers
- Bass amplifiers
- Guitar amplifiers
- PA speakers and line arrays

Please see application examples on next slide.

# AS Series Size and Power

**ICEpower100AS1**  
Amplifier and power supply  
100 W @ 1 % (20 Hz - 20 kHz, 4 Ω)

**ICEpower100AS2**  
Amplifier and power supply  
2 x 100 W @ 1 % (20 Hz - 20 kHz, 4 Ω)

1 x 100  
watt

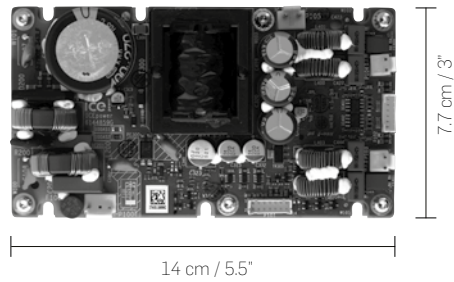
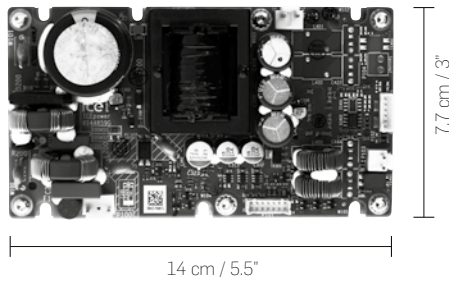

**ICEpower300AS1**  
Amplifier and power supply  
300 W @ 1 % (20 Hz - 20 kHz, 4 Ω)

**ICEpower300A1**  
Amplifier  
300 W @ 1 % (20 Hz - 20 kHz, 4 Ω)

1/2 x 300  
watt

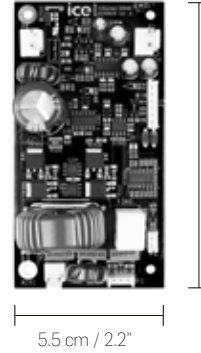

**ICEpower700AS1**  
Amplifier and power supply  
700 W @ 1 % (20 Hz - 20 kHz, 4 Ω)

1 x 700  
watt

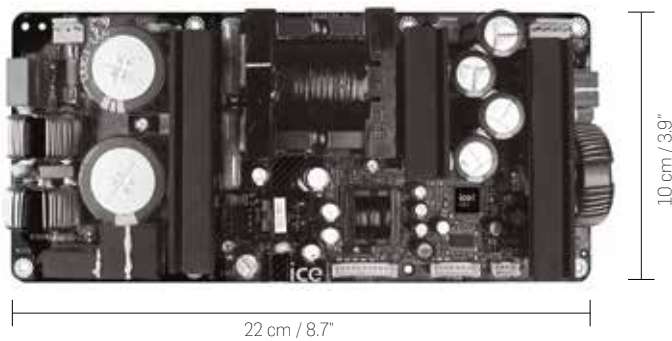

# AS Series Size and Power

ICEpower700AS2  
Amplifier and power supply  
2 x 700 W @ 1 % (20 Hz - 20 kHz, 4 Ω)

2 x 700  
watt

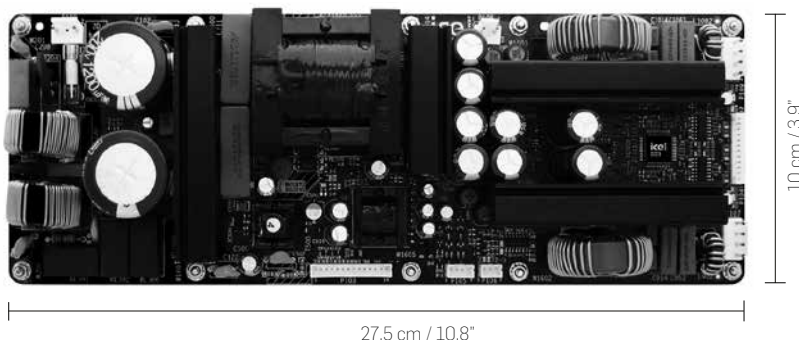

27.5 cm / 10.8"

10 cm / 3.9"

ICEpower1200AS1  
Amplifier and power supply  
1 x 1200 W @ 1 % (20 Hz - 20 kHz, 4 Ω)

1 x 1200  
watt

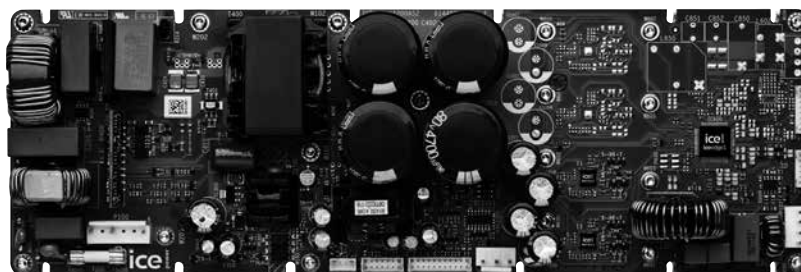

30 cm / 11.8"

10 cm / 3.9"

ICEpower1200AS2  
Amplifier and power supply  
2 x 1200 W @ 1 % (20 Hz - 20 kHz, 4 Ω)

2 x 1200  
watt



30 cm / 11.8"

10 cm / 3.9"

# Application

# Solution

Active subwoofer  
 1 x 300 W / 4 Ω  
 1 x 700 W / 4 Ω  
 1 x 1200 W / 4 Ω

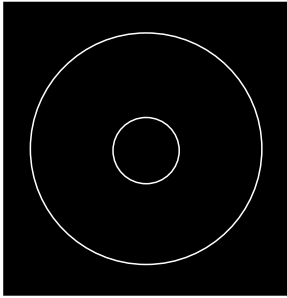

- 1 x 300AS1
- 1 x 700AS1
- 1 x 1200AS1

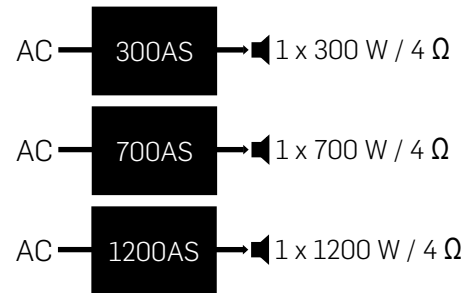

Stereo amplifier  
 2 x 50 W / 8 Ω  
 2 x 150 W / 8 Ω  
 2 x 350 W / 8 Ω  
 2 x 600 W / 8 Ω



- 1 x 100AS2
- 1 x 300AS1  
1 x 300A1
- 1 x 700AS2
- 1 x 1200AS2

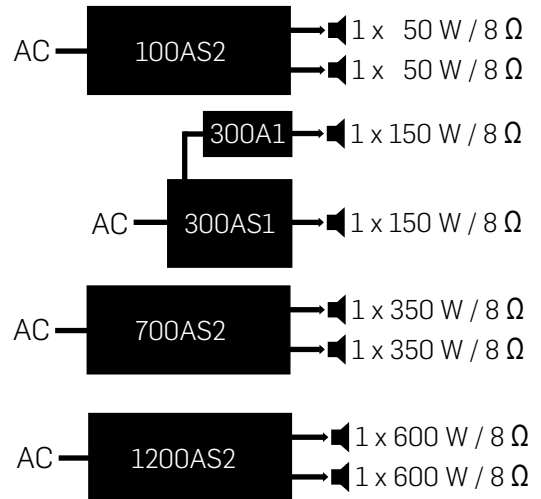

Home theater amplifier  
 5 x 150 W / 8 Ω



- 2 x 300AS1  
3 x 300A1

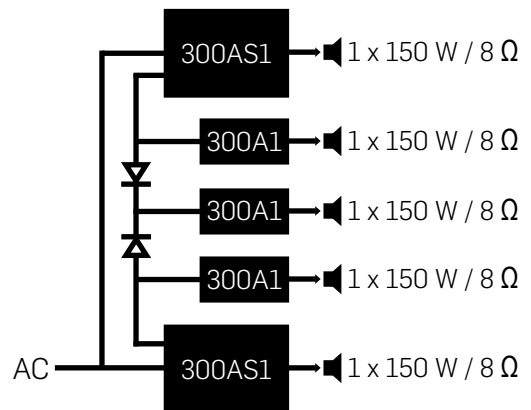



## Application

## Solution

3-way active speaker /  
studio monitor  
2 x 150 W / 8 Ω  
1 x 300 W / 4 Ω

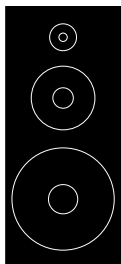

→ 1 x 300AS1  
2 x 300A1

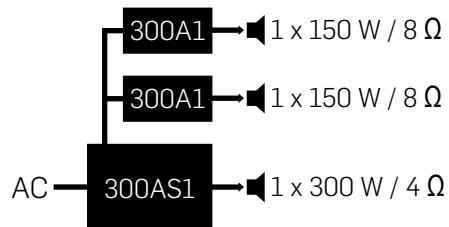

Bass amplifier  
1 x 100 W / 4 Ω  
1 x 300 W / 4 Ω  
1 x 700 W / 4 Ω  
1 x 1200 W / 4 Ω

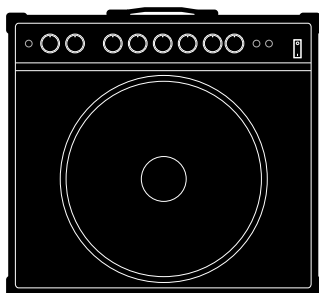

→ 1 x 100AS1

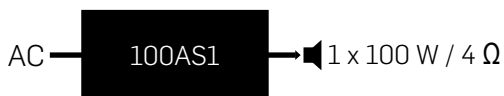

→ 1 x 300AS1

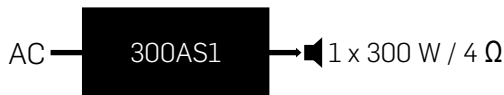

→ 1 x 700AS1

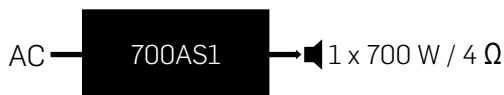

→ 1 x 1200AS1



Line array and PA speaker  
1 x 350 W / 8 Ω  
1 x 700 W / 4 Ω

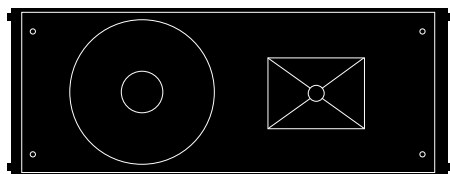

→ 1 x 700AS2

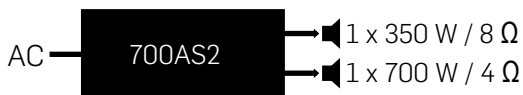

→ 1 x 1200AS2

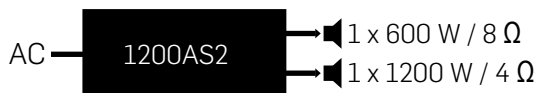

1 x 600 W / 8 Ω  
1 x 1200 W / 4 Ω

## Feature Set Summary

	100AS1/2	300AS1	300A1	700AS1/2	1200AS1/2
Universal Mains SMPS (85 - 264 VAC, 47 Hz - 63 Hz)	✓	✓		✓	✓
ErP (1275 / 2008 / EC) compliant standby mode with less than 0.5W power consumption	✓	✓	✓	✓	✓
+/-12 V Regulated auxillary power supply DC output	✓ (+/-17 $\mu$ V)	✓ (+/-12 $\mu$ V)		✓ (+/-15 $\mu$ V)	✓ (+/-15 $\mu$ V)
+5 V Regulated auxillary power supply DC output	✓ (+ 7 $\mu$ V)	✓		✓	✓
Auto-start or wake up on signal (signal sense)	✓	✓		✓	✓
DC-Bus output for powering additional amplifiers	✓	✓		✓	✓
Balanced input and output	✓	✓	✓	✓	✓
Soft start-up and mute/de-mute	✓	✓	✓	✓	✓
Comprehensive protection scheme (thermal, over-current, high-frequency, under-voltage)	✓	✓	✓	✓	✓
Mechanically rugged construction (Tested for 70G shocks in six directions)	✓	✓	✓	✓	✓
Pre-approved for Safety, EMC and RoHS compliance	✓	✓	✓	✓	✓

AS - Amplifier and Power Supply, e.g.  
 xxxAS1/2 - xxx W per channel, Amplifier and Power Supply 1 channel / 2 channel.

## Key Performance Parameters

	100AS1/2	300AS1	300A1	700AS1/2	1200AS1/2
Amplifier Output Power per channel 1 % THD+N, 20 Hz - 20 kHz	100 W (4 $\Omega$ ) 50 W (8 $\Omega$ )	300 W (4 $\Omega$ ) 150 W (8 $\Omega$ )	300 W (4 $\Omega$ ) 150 W (8 $\Omega$ )	700 W (4 $\Omega$ ) 350 W (8 $\Omega$ )	1200 W (4 $\Omega$ ) 600 W (8 $\Omega$ )
Amplifier Output Power per channel 10 % THD+N, 20 Hz - 20 kHz	135 W (4 $\Omega$ )	380 W (4 $\Omega$ )	380 W (4 $\Omega$ )	800 W (4 $\Omega$ )	1400 W (4 $\Omega$ )
Minimum load impedance	3 $\Omega$	2.5 $\Omega$	2.5 $\Omega$	2.5 $\Omega$	2.7 $\Omega$
Maximum amplifier efficiency	-	-	90 %	-	-
Maximum total amp+psu efficiency	72 %	80 %	-	84 %	80 %
Supply voltage input	85-264 VAC	85-264 VAC	22-55 VDC	85-264 VAC	85-264 VAC
Peak output current	12 A	20 A	20 A	30 A	38 A
Dynamic range	109 dB	113 dB	113 dB	117 dB	129 dB
Output referenced idle noise (A-weighted)	77 $\mu$ V	75 $\mu$ V	75 $\mu$ V	70 $\mu$ V	25 $\mu$ V
THD+N 1 W/1 kHz	0.005 %	0.006 %	0.006 %	0.006 %	0.005 %
Output impedance	200 m $\Omega$	6 m $\Omega$	6 m $\Omega$	7 m $\Omega$	5 m $\Omega$



# Audio Performance 100AS1/2

100AS1/2 THD+N vs. output power

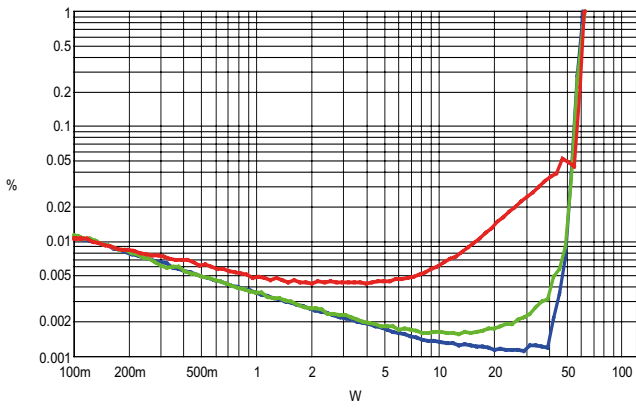

THD+N vs. Po at 100 Hz, 1 kHz and 6.67 kHz (8  $\Omega$ ), 230 Vac / 50 Hz

100AS1/2 THD+N vs. output power

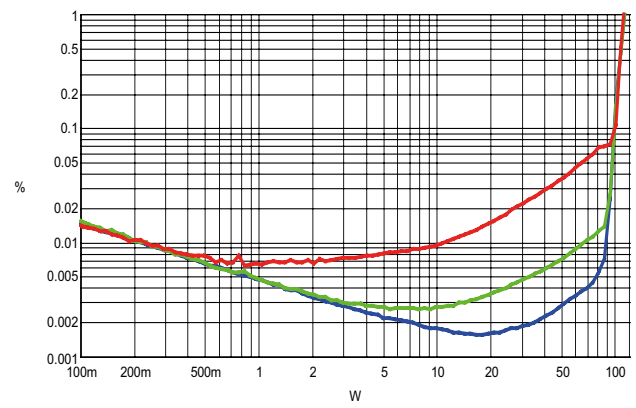

THD+N vs. Po at 100 Hz, 1 kHz and 6.67 kHz (4  $\Omega$ ), 230 Vac / 50 Hz

100AS1/2 Frequency Response

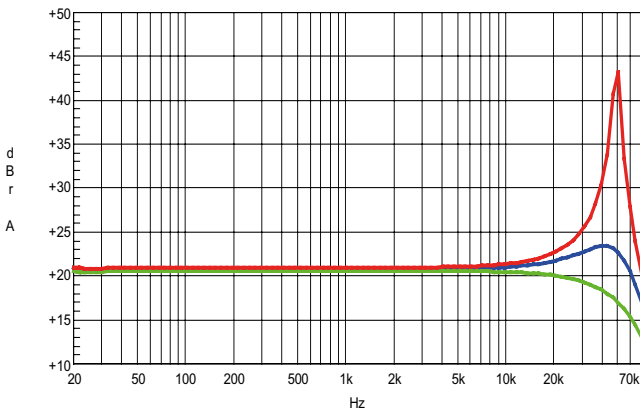

In 4  $\Omega$ , 8  $\Omega$  and open load. Amplitude.

100AS1/2 Idle Noise

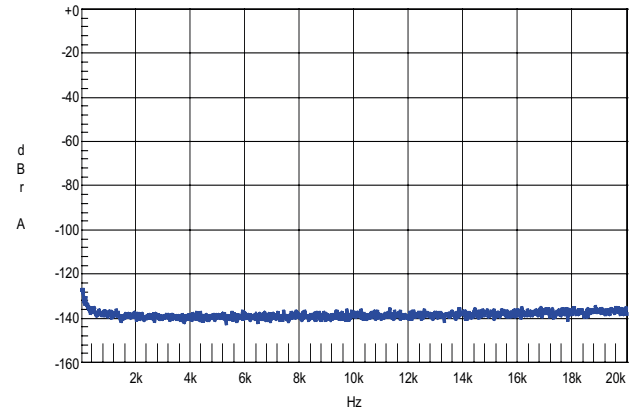

Idle noise (16 k FFT). Residual = 77  $\mu$ V(A)

# Audio Performance 300AS1/A1

300AS1/A1 THD+N vs. output power

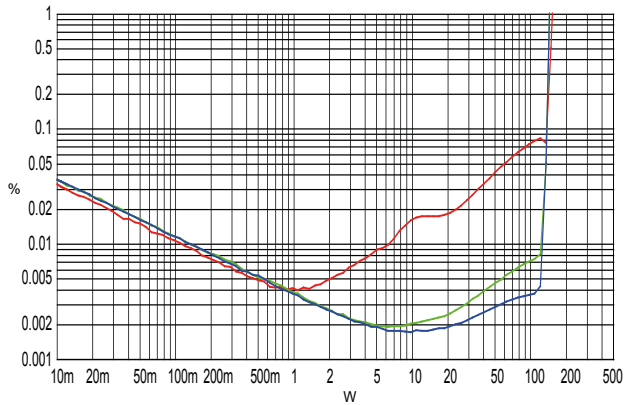

THD+N vs. Po at 100 Hz, 1 kHz and 6.67 kHz (8 Ω), 230 Vac / 50 Hz

300AS1/A1 THD+N vs. output power

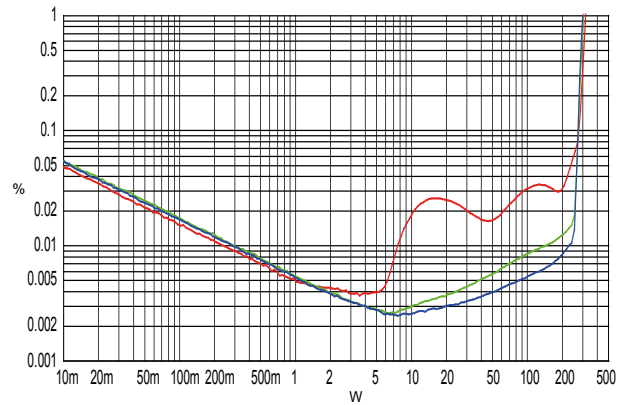

THD+N vs. Po at 100 Hz, 1 kHz and 6.67 kHz (4 Ω), 230 Vac / 50 Hz

300AS1/A1 Frequency Response

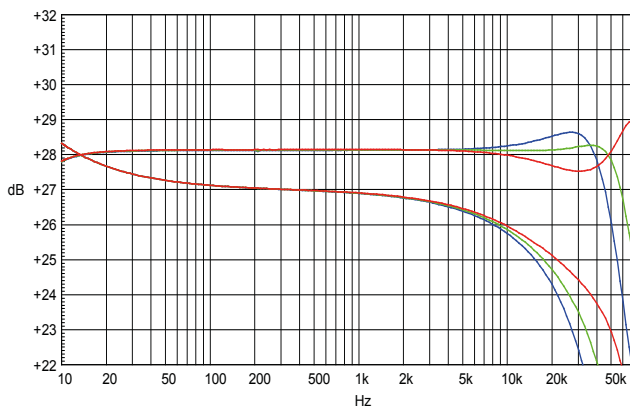

In 4 Ω, 8 Ω and open load. Top - amplitude. Bottom - phase

300AS1/A1 Idle Noise

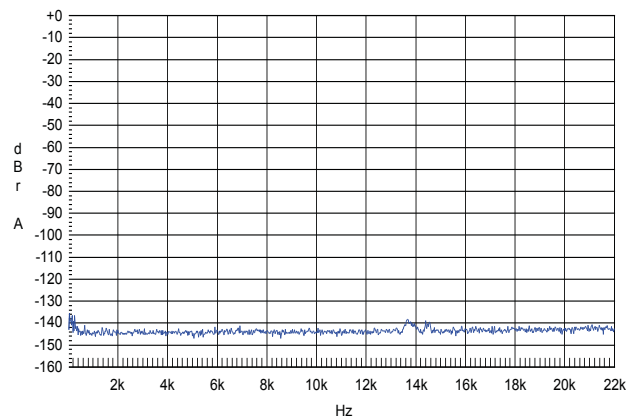

Idle noise (16 k FFT). Residual = 75 μV(A)

# Audio Performance 700AS1/2

700AS1/2 THD+N vs. output power

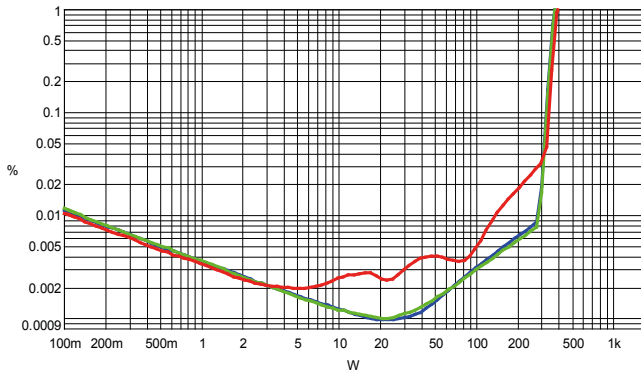

THD+N vs. Po at 100 Hz, 1 kHz and 6.67 kHz (8 Ω), 230 Vac / 50 Hz

700AS1/2 THD+N vs. output power

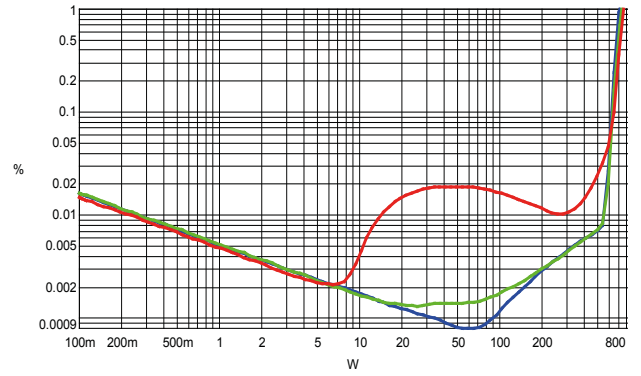

THD+N vs. Po at 100 Hz, 1 kHz and 6.67 kHz (4 Ω), 230 Vac / 50 Hz

700AS1/2 Frequency Response

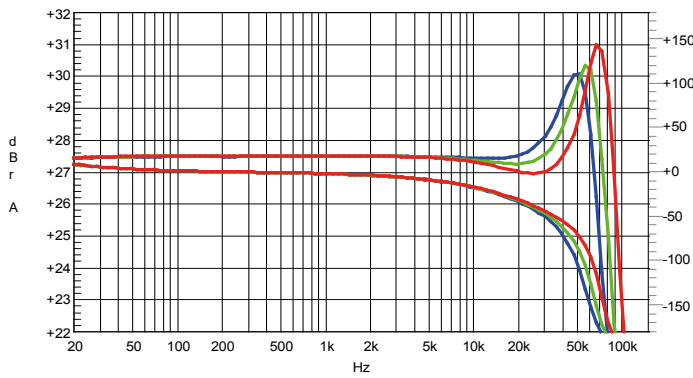

In 4 Ω, 8 Ω and open load. Top - amplitude. Bottom - phase

700AS1/2 Idle Noise

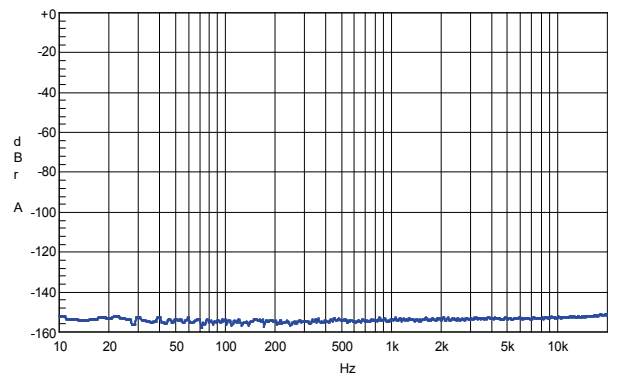

Idle noise (16 k FFT). Residual = 70 μV(A)

# Audio Performance 1200AS1/2

1200AS1/2 THD+N vs. output power

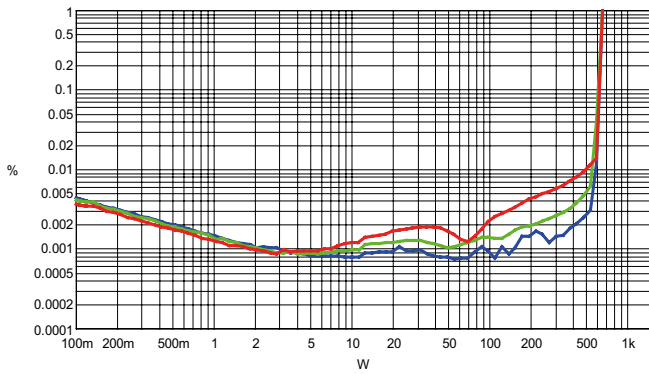

THD+N vs. Po at 100 Hz, 1 kHz and 6.67 kHz (8 Ω), 230 Vac / 50 Hz

1200AS1/2 THD+N vs. output power

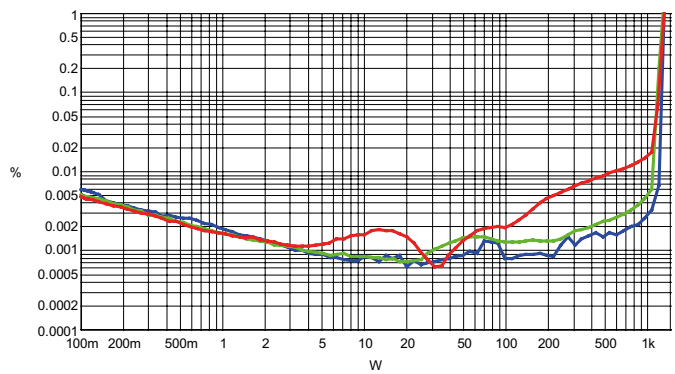

THD+N vs. Po at 100 Hz, 1 kHz and 6.67 kHz (4 Ω), 230 Vac / 50 Hz

1200AS1/2 Frequency Response

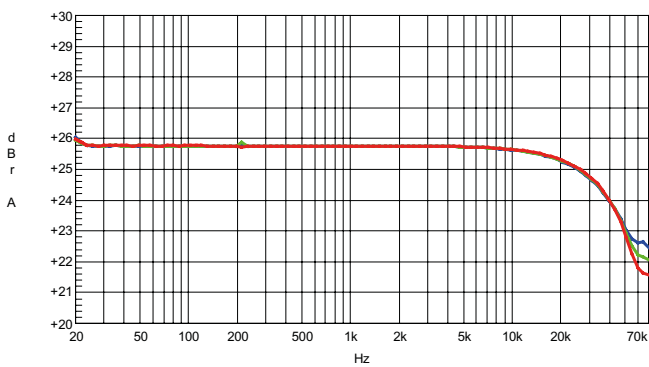

In 4 Ω, 8 Ω and open load. Amplitude.

1200AS1/2 Idle Noise

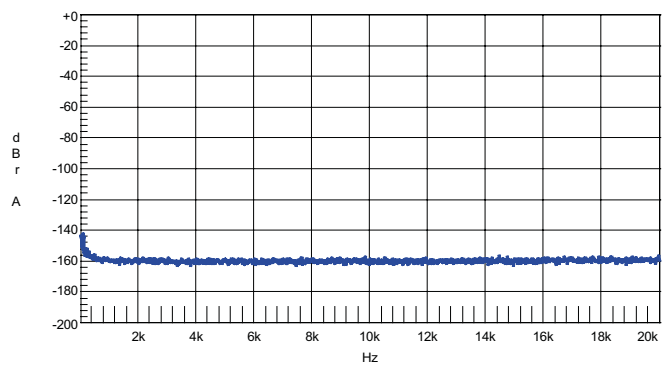

Idle noise (16 k FFT). Residual = 25 μV(A)

# About ICEpower

ICEpower is an innovative Danish company developing and manufacturing energy efficient, high performance class D audio solutions for consumer, professional, automotive and portable audio applications. Our products are based on a range of innovative, proprietary technologies that deliver the best audio performance, efficiency and power density in the industry.

The company was founded in 1999 by Bang & Olufsen, based on the technologies developed in a joint research project between Bang & Olufsen and the Danish Technical University (DTU), where significant improvements were achieved in efficiency and audio quality of switching technologies. Today, ICEpower is a company of 40 employees and an independent company, owned by the management team.

We are proud of the fact that ICEpower was one of the first companies to pioneer the audio industry's change from analogue technologies to highly efficient switching technologies, bringing about a true paradigm shift in the industry. Our technologies have raised the efficiency of audio amplifiers and power supplies from 50-70 %, possible with traditional analogue technologies, to 80-95 % – making audio devices "greener".

Today, we continue our focus on enhancing the efficiency, audio performance and power density in the audio power conversion chain. We work hard to stay on the forefront of technological development in our niche, continuously working to enhance our technological portfolio through in-house development, academic collaboration and partnerships with other industry players.

Since our establishment, we have cooperated with over 500 loyal customers and partners all over the world. Among them are some of the world's most respected companies.

Please visit us at [ICEpower.dk](http://ICEpower.dk) for further information about our products, our technologies and our company.

## EUROPE (HQ)

ICEpower a/s  
Vandtårnsvej 62A  
DK-2860 Søborg  
Denmark  
[info@icepower.dk](mailto:info@icepower.dk)  
[www.icepower.dk](http://www.icepower.dk)  
Tel. +45 31 71 00 01

## NORTH AMERICA

ICEpower America  
1800 W Roscoe St.  
Unit 313  
Chicago  
IL 60657  
Tel. +1 847 909 0093

## ASIA

ICEpower Japan  
304 Y's cube 4-12-7  
Shin-Kamagaya  
Kamagaya-shi  
Chiba 273-0107, Japan  
Tel. +81 80 3396 9208

## TAIWAN

ICEpower Taiwan  
10F, No. 66, Sec. 1  
Neihu Rd. Neihu Dist.  
Taipei 11493  
Taiwan, R.O.C.  
Tel. +886 905 069 713